

Varenummer: 20289B50V50S2SW

Beskrivelse: E+G Rørholder - GN 289-B50-V50-S-2-SW

Mål

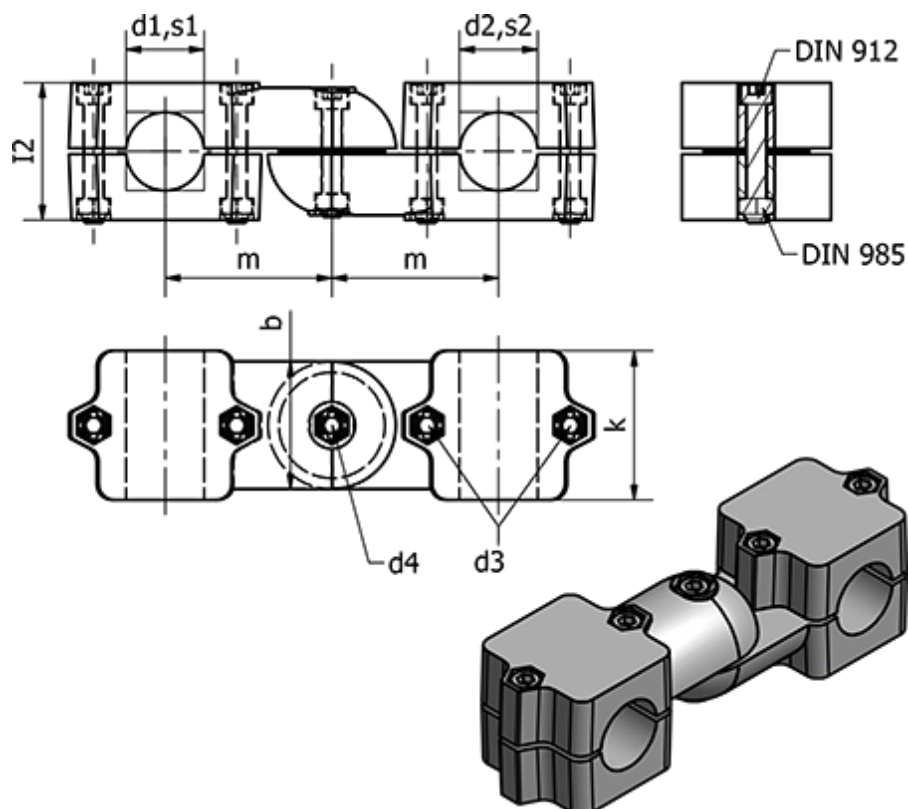

b	= 65	l2	= 70
d1	= B50	k	= 76
d2	= -	m	= 85
d3	= M10	s1	= -
d4	= M10	s2	= V50
Fastspændings kit for d3 = GN 911-M10-55		Vægt (g)	= 1593
Fastspændings kit for d4 = GN 911-M10-63			
l1	= 268		